



Differential Positive ECL (DPECL) SK-2900 Series

Description

The **SK-2900 Series** of quartz crystal oscillators provide DPECL Fast Edge compatible signals. This device is to operate using positive voltage and uses multiple ground pins for improved signal integrity. This device is intended to operate on positive voltage for PECL applications.

Features

- Wide frequency range—250.0MHz to 500.0MHz
- User specified tolerance available
- Case at electrical ground
- Will withstand vapor phase temperatures of 253°C for 4 minutes maximum
- All metal, resistance weld, hermetically sealed package
- High shock resistance, to 1500g
- Low Jitter
- Overtone technology
- High Q Crystal actively tuned oscillator circuit
- Power supply decoupling internal
- Dual ground plane for added stability
- No internal PLL avoids cascading PLL problems
- High frequencies due to proprietary design

Electrical Connection

Pin	Connection
1	V _{CC}
2	V _{EE} Case
6	V _{EE} Case
7	Output
8	/Output
9	V _{EE} Case
13	V _{EE} Case
14	Enable/Disable

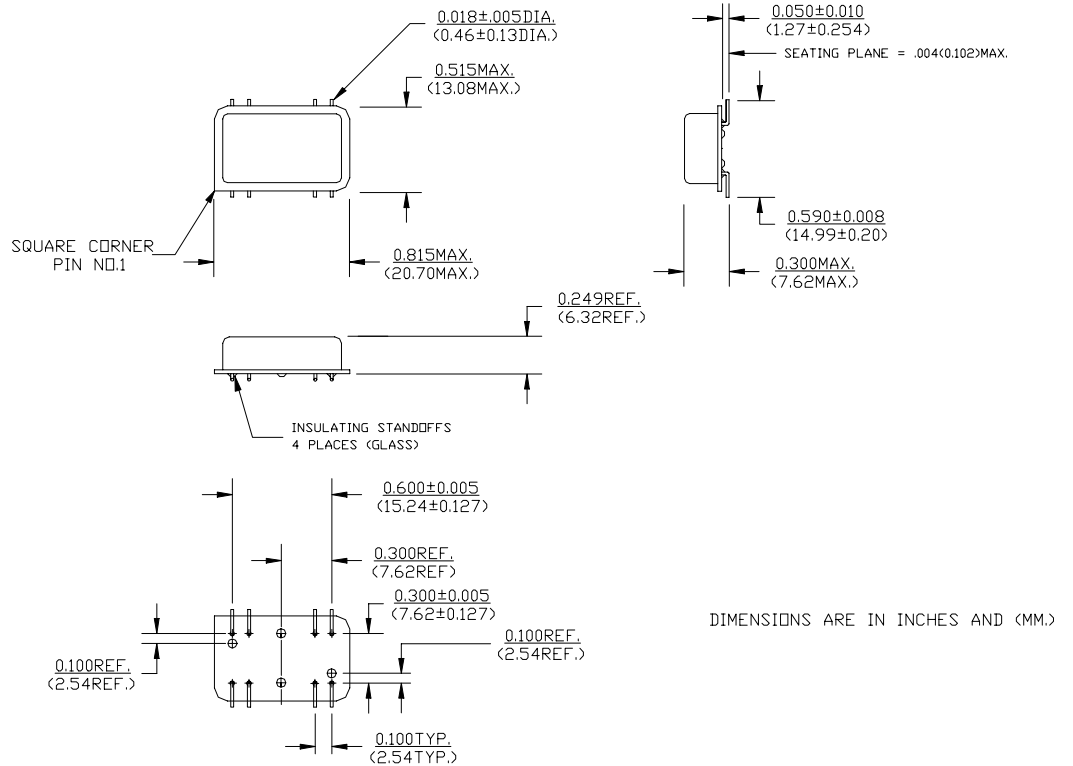

SK-2900 Series Continued Differential Positive ECL (DPECL)

Rev. C

Operating Conditions and Output Characteristics

Electrical Characteristics

Parameter	Symbol	Conditions	Min	Typical	Max
Frequency	-----	-----	250.0MHz	-----	500.0MHz
Duty Cycle	-----	@ 50% points	45/55%	-----	55/45%
Logic 0 ⁽²⁾	V _{OL}	-----	V _{CC} -1.95V	-----	V _{CC} -1.60V
Logic 1 ⁽²⁾	V _{OH}	-----	V _{CC} -1.02V	-----	V _{CC} -0.74V
Rise & Fall Time	tr,tf	20-80%V _O with 50 ohm load to V _{CC} -2V	-----	350 psec	600 psec
Jitter, RMS ⁽³⁾	-----	-----	-----	-----	5 psec
Enable Voltage ⁽⁴⁾	-----	with V _{EE} =0V	0V	-----	1.0V
Disable Voltage	-----	with V _{EE} =0V	3.0V	-----	V _{CC}
Frequency Stability ⁽¹⁾	dF/F	Overall conditions including: voltage, calibration, temp., 10 yr aging, shock, vibration	-100ppm	-----	+100ppm

General Characteristics

Parameter	Symbol	Conditions	Min	Typical	Max
Supply Voltage	V _{CC}	-----	4.75V	5.0V	5.25V
Supply Current	I _{CC}	50 ohm termination To 2.00V below V _{CC}	0.0 mA	-----	120 mA
Output current	I _O	Low level Output Current	0.0 mA	-----	±50.0 mA
Operating temperature	T _A	-----	0°C	-----	70°C
Storage temperature	T _S	-----	-55°C	-----	125°C
Input: Logic High (ECL) - Disables V _{EE} or Open - Enables					
Lead temperature	T _L	Soldering, 10 sec.	-----	-----	300°C
Load		50 Ohm to V _{CC} -2V or Thevenin Equivalent, Bias Required			
Start-up time	t _s	-----	-----	2 ms	10 ms

Environmental and Mechanical Characteristics

Mechanical Shock	Per MIL-STD-202, Method 213, Condition E
Thermal Shock	Per MIL-STD-833, Method 1011, Condition A
Vibration	0.060" double amplitude 10 Hz to 55 Hz, 35g's 55Hz to 2000 Hz
Soldering Condition	300°C for 10 seconds
Hermetic Seal	Leak rate less than 1 x 10 ⁻⁸ atm.cc/sec of helium

Footnotes:

- 1) Standard frequency stability (±20,±25,±50ppm & others available)
- 2) V_{OL}, V_{OH}, referenced to ground
- 3) Jitter performance is frequency dependent. Please contact factory for full characterization.
- 4) Open to Enable pin also enables to output.

Creating a Part Number	
SK - A290X - FREQ	
Package Code	Tolerance/Performance
HK Leaded 8 pin (14pin)	0 ±100ppm 0-70°C
SK 8 pin (14 pin) SMD Gull Wing	1 ±50ppm 0-70°C
	7 ±25ppm 0-70°C
Input Voltage	9 Customer Specific
Code Specification	A ±20ppm 0-70°C
A 3.3V	B ±50ppm -40 to +85°C
5V	C ±100ppm -40 to +85°C

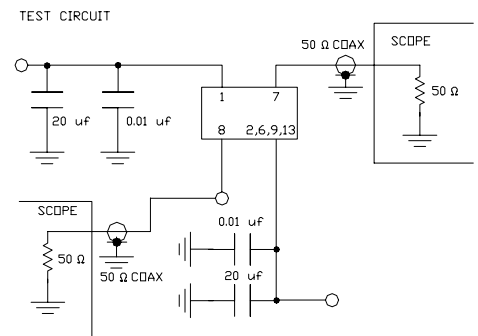

TEST CIRCUIT USES A SPLIT SUPPLY OF +2V AND -3V FOR EASE OF TESTING.